

eduard
MASK

F-111 Aardvark 1/48

The die-cut mask for accurate canopy frame painting of the
Academy 1/48 KIT

EX 122

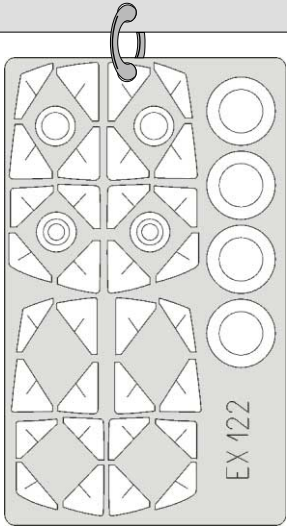

2pcs
86

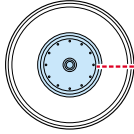

2pcs
86

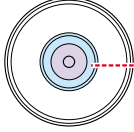

LIQUID MASK ■

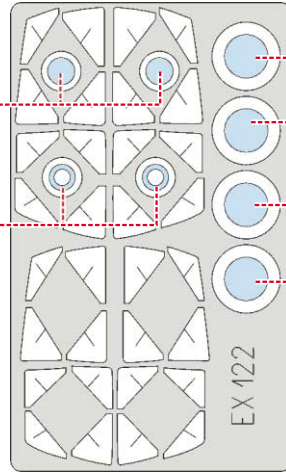

2pcs
79

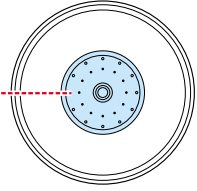

2pcs
80

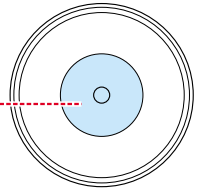

?

2pcs
86

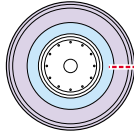

2pcs
86

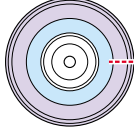

LIQUID MASK ■

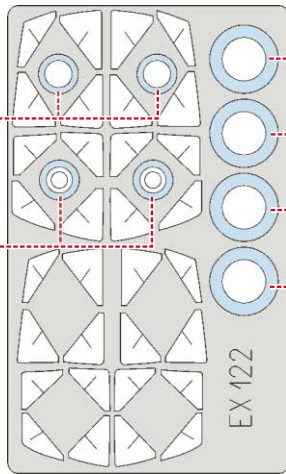

?
2pcs
79

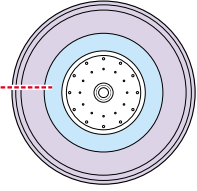

2pcs
80

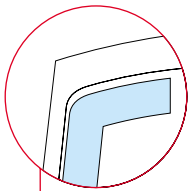
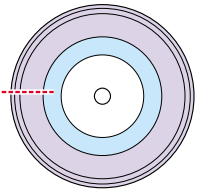

1.)
63

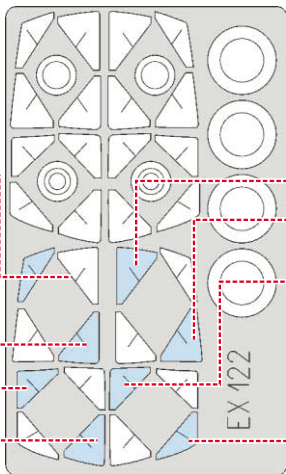
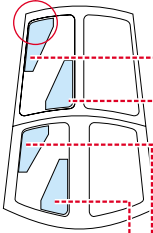

2.)
63

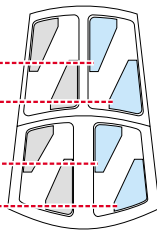

3.)
63

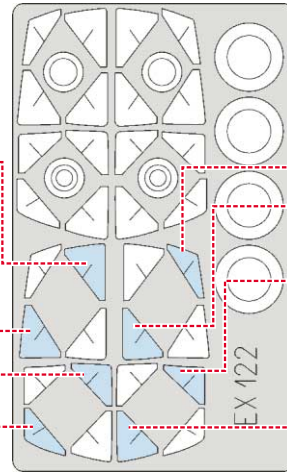
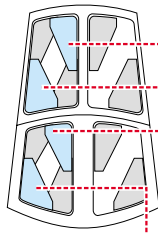

4.)
63

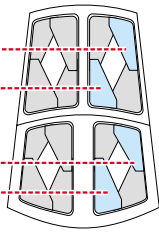

5.)  INTERIOR COLOR

6.)  RUBBER COLOR

7.) REMOVE MASK

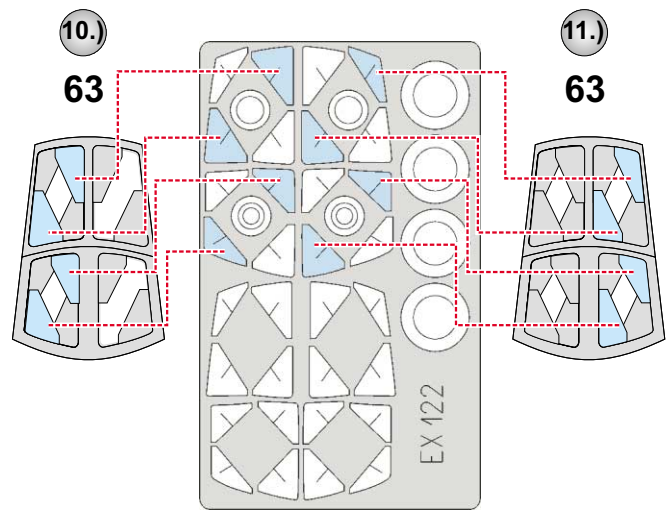
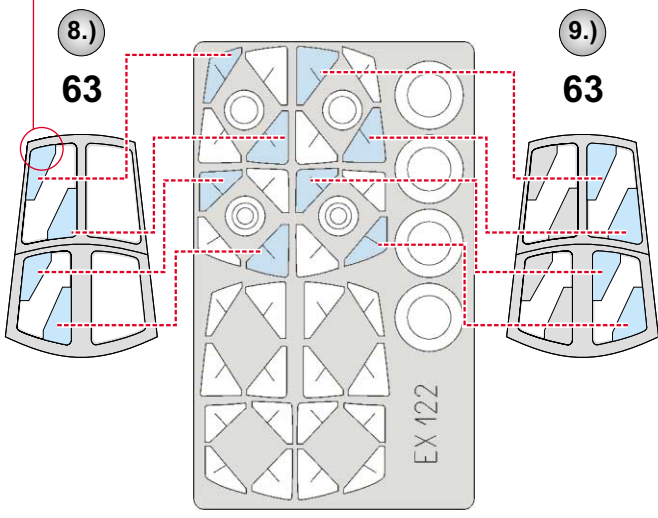
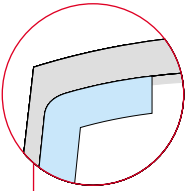
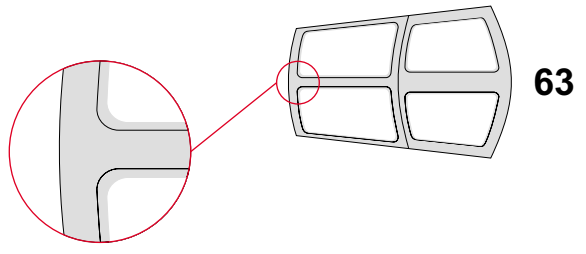
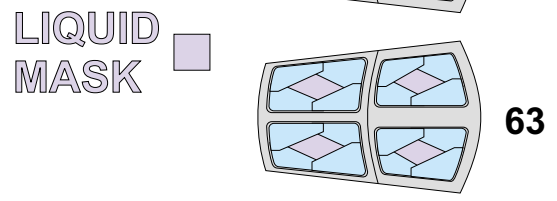
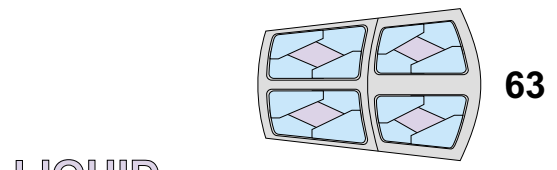

12.)  CAMOUFLAGE COLOR

13.) REMOVE MASK

