

eduard
MASK

F-4E/J Phantom II 1/32

The die-cut mask for accurate canopy frame painting of the
Tamiya 1/32 KIT *ITEM 60310*

JX 004

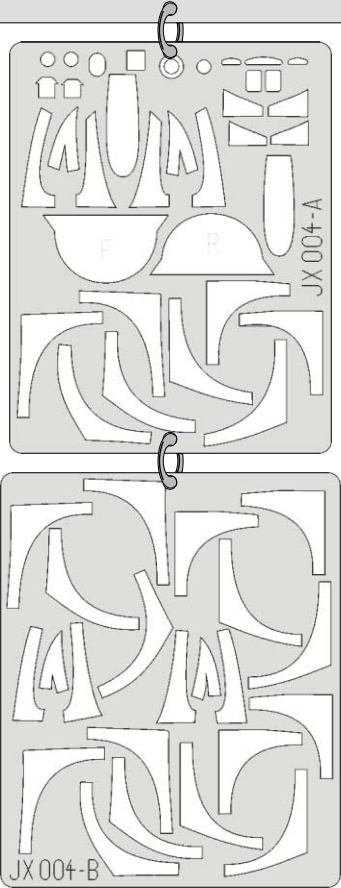

2pcs
D17

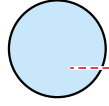

D18

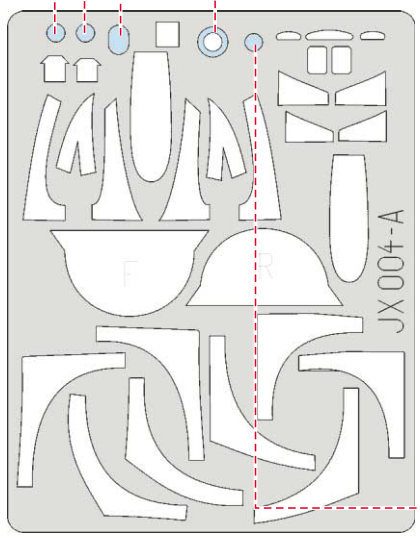
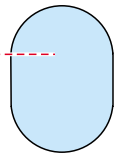

L28

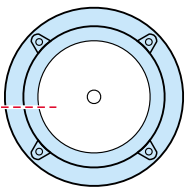

L46

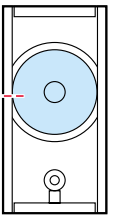

D6

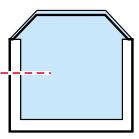

D6

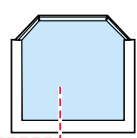

D1

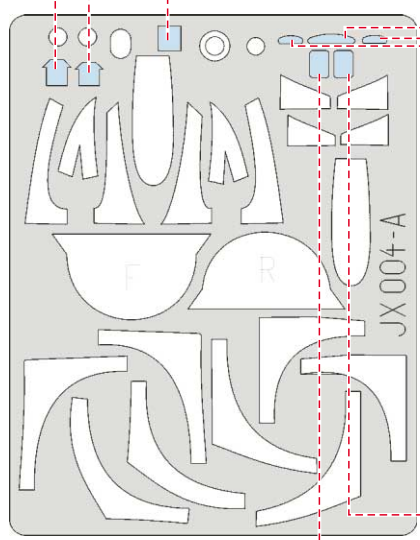
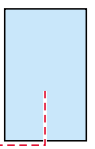

F27

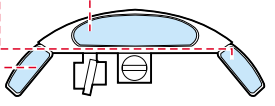

D13

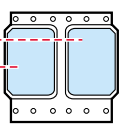

REFERENCES:
 IN DETAIL & SCALE VOL.7 - F-4 PHANTOM II
 REPLIC #53 / 1996
 REPLIC #57 / 1996
 REPLIC #125 / 2002

LIQUID MASK



1.)

D5

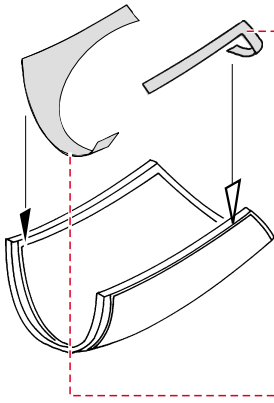

1.)

D6

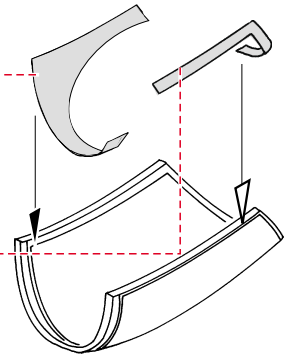

2.)

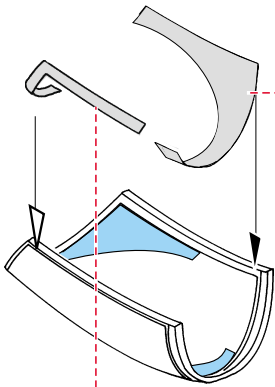

2.)

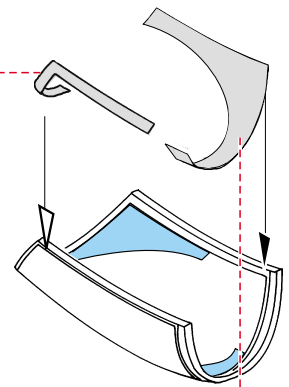

3.)

INTERIOR COLOR

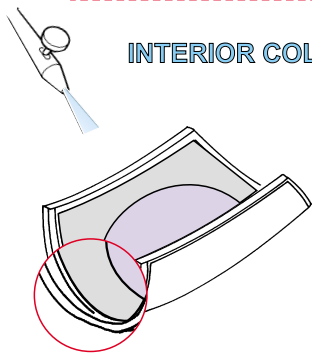

3.)

INTERIOR COLOR

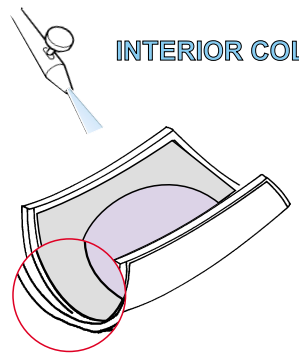

D5

D6

1.)

INTERIOR COLOR

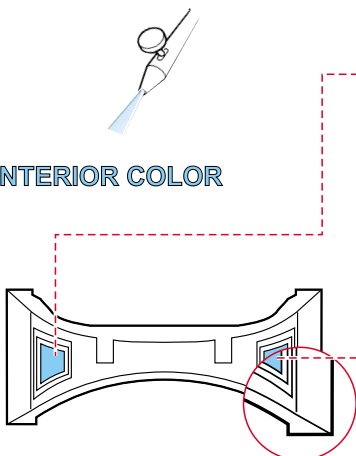

2.)

RUBBER COLOR

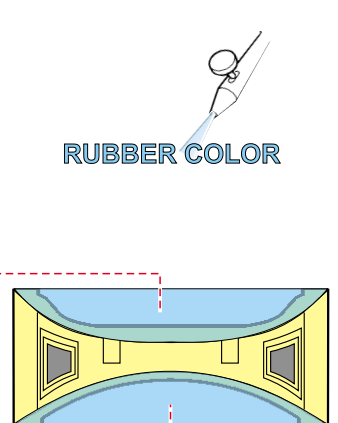

D3

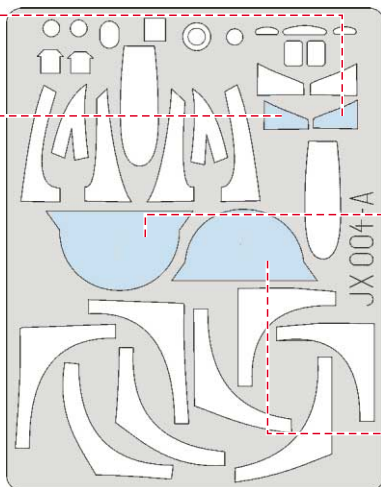
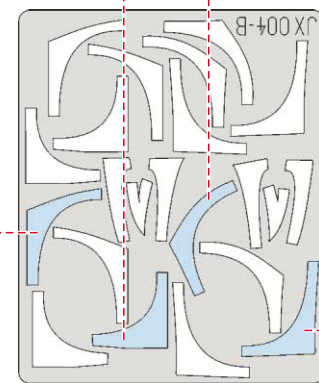
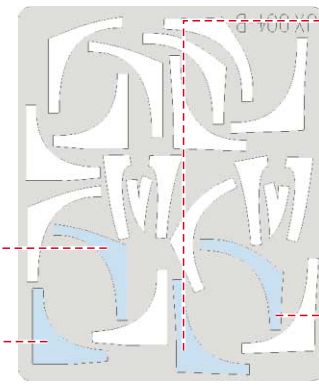

3.)

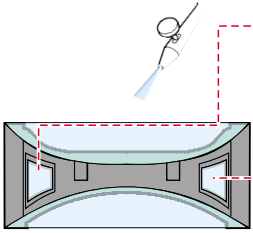

CAMOUFLAGE COLOR

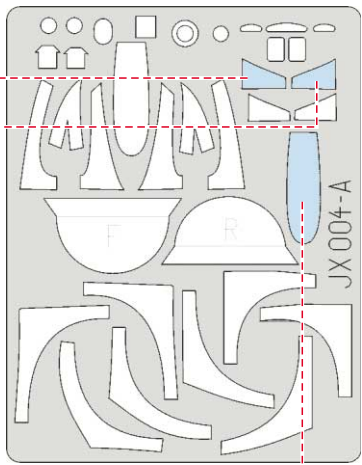

4.)

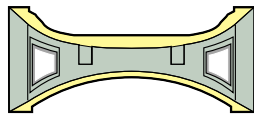

1.)

D4

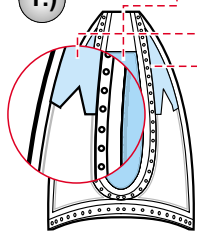

2.)

D4

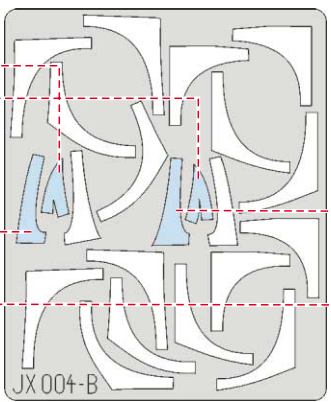
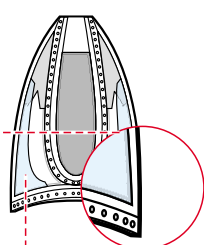

3.)

D4

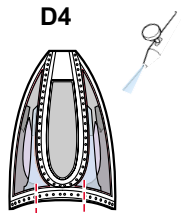

INTERIOR COLOR

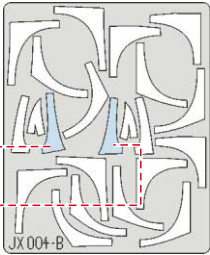

4.)

D4

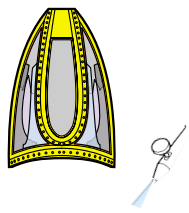

RUBBER COLOR

5.)

D4

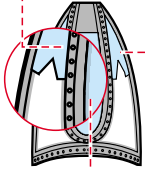

6.)

D4

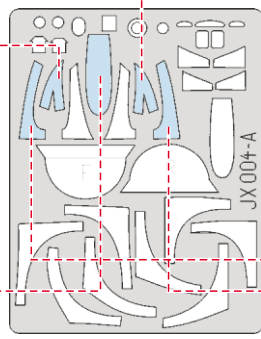
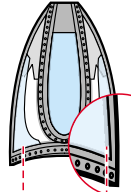

7.)

D4

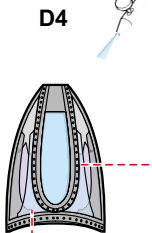

CAMOUFLAGE COLOR

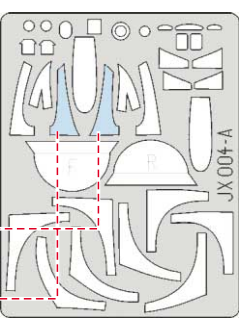

8.)

D4

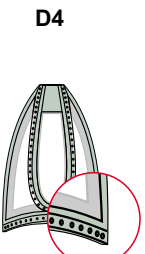

1.)

D6

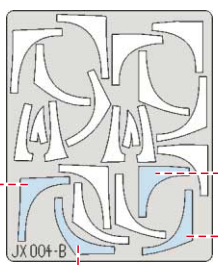
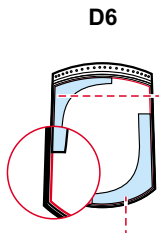

D5

