

# 648 066 R-2800-31 engine

For P-61A  
For Great Wall Hobby kit



**eduard**  
**BRASSIN**

1/48 scale

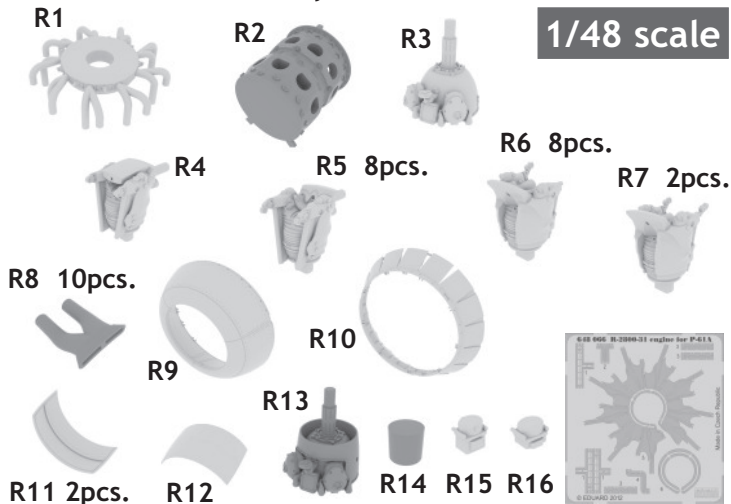

This product contains metal and resin detail parts for upgrading scale plastic models. When selecting this set make sure that it is for the kit mentioned in product name as these sets are made specifically for that kit. When upgrading the model some cutting or corrections may be necessary for parts to fit accurately. **WARNING!** This set contains small and sharp parts. Work carefully in a ventilated and well-lit room. Safety glasses are recommended. This product is not suitable for children below 14 years of age.

Tento výrobek obsahuje leptané a odlévané detaily pro úpravu a vylepšení plastického modelu. Při výběru sady kovových detailů zkontrolujte, zda je určena pro model, který chcete upravit. Model, pro který je sada určena, je uveden u názvu výrobku. Pro přesnou aplikaci kovových a odlévaných dílů může být zapotřebí upravit díly upravovaného modelu. **POZOR!** Sada obsahuje malé ostré díly. Pracujte ve větrané a dobře osvětlené místnosti. Doporučujeme použít ochranných brýlí. Tento výrobek není vhodný pro děti mladší 14 let.

**eduard**

435 21 Obrnice 170  
Czech Republic

[www.eduard.com](http://www.eduard.com)



# 648 066 R-2800-31 engine for P-61A 1/48

For Great Wall Hobby kit

**BRASSIN**

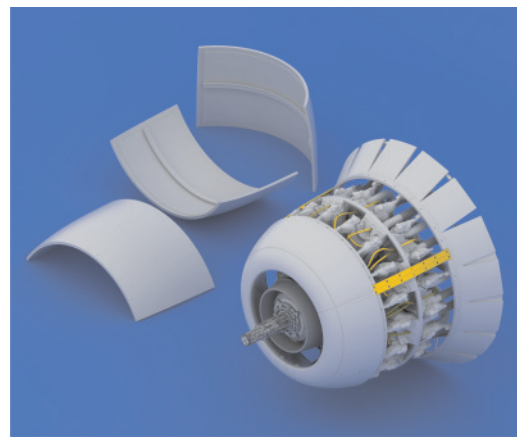

**BRASSIN**

**eduard**

## RELATED PRODUCTS FOR P-61

648 057 P-61 wheels

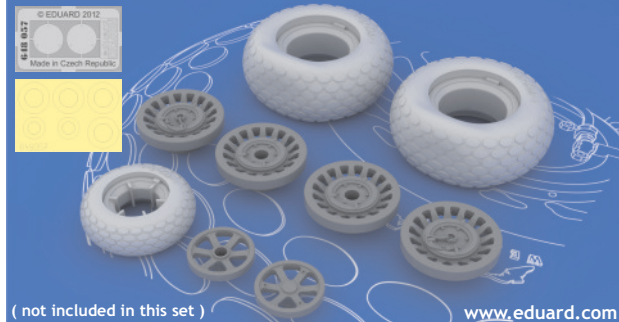

**BEST BRASS RESIN AROUND!**

 SYMMETRICAL ASSEMBLY  
SYMETRICKÁ MONTÁŽ

 REMOVE  
ODSTRANIT  BEND  
OHNOUT

 GRIND  
OBROUSIT  ? OPTION  
VOLBA

 DRILL HOLE  
VRTAT OTVOR  REPLACE  
NAHRADIT

**R6 - 7 pcs.**  
**R7 - 2 pcs.**

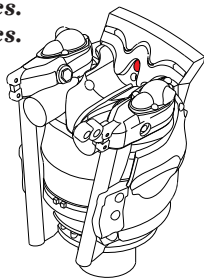

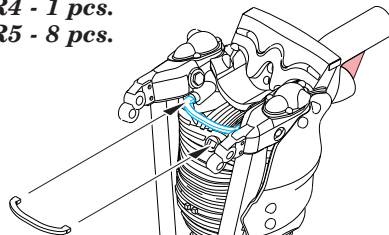

 = ●  
0,5 mm

**R4 - 1 pcs.**  
**R5 - 8 pcs.**



**PE3**  
use only for R5

 = 

**A**

**R6 - 7 pcs.**

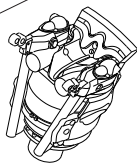

**R7**

**R5 - 8 pcs.**

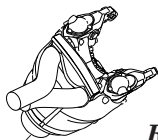

**R4**

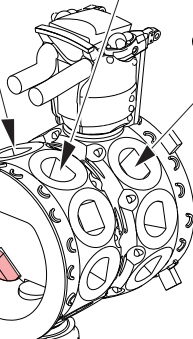

**R2**

**R7**

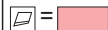
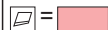
 = 

**R15**  **R16**



**R13**

?

**R3**

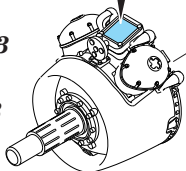

**PE6**

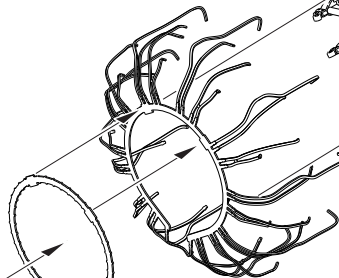

**PE5**

**A**

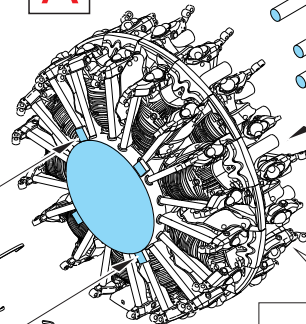

**R1**

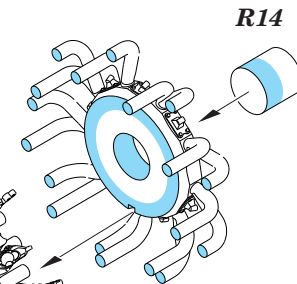

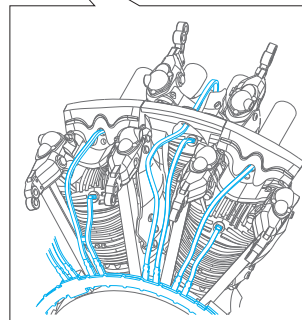

**R14**

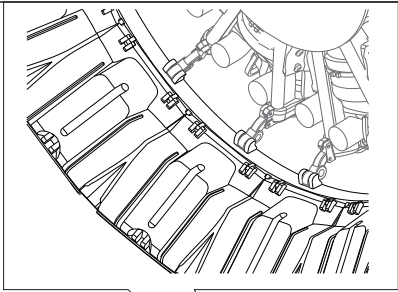
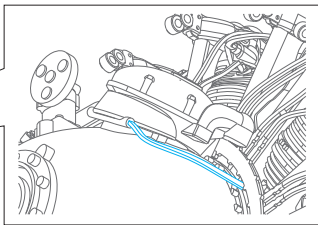
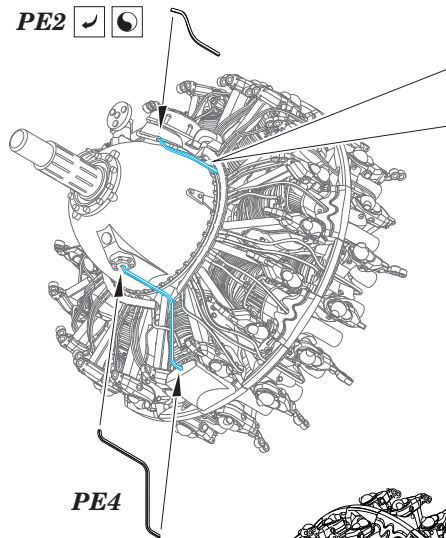

**R15 - ONLY FOR SEPARATE ENGINE ASSEMBLY**

PE2  



plastic  
E1, E6  
  
D1, D8

PE4

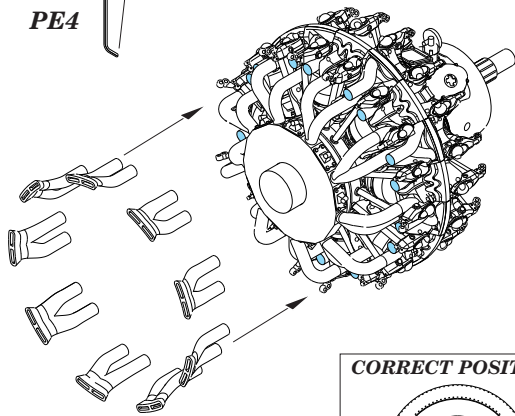

R8 - 9 pcs.

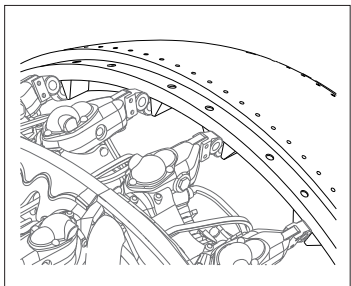

R10

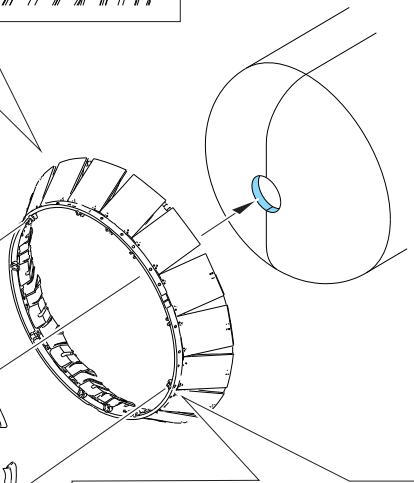

R9

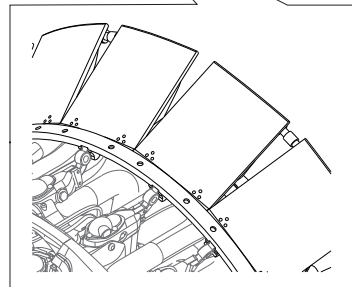
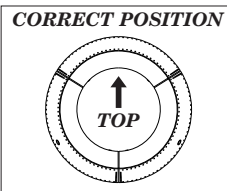
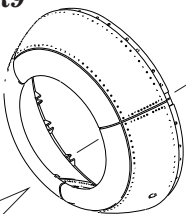

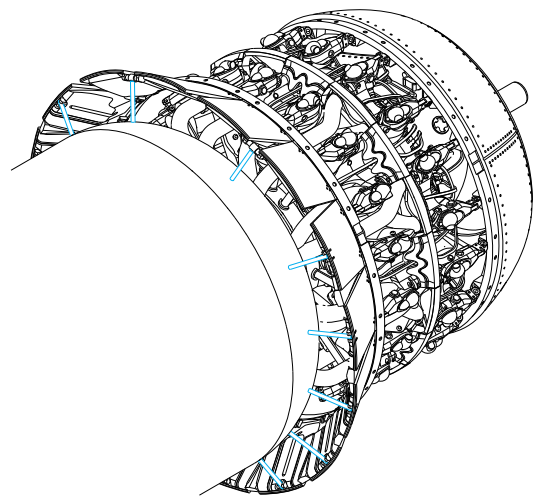

wire 14 pcs.

∅ - 0,3 mm

l - 3,6 mm

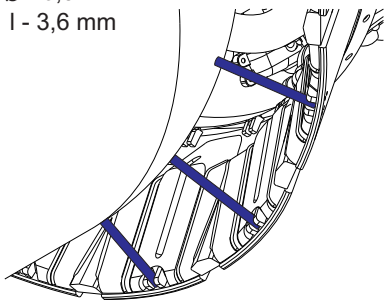

R11 ?

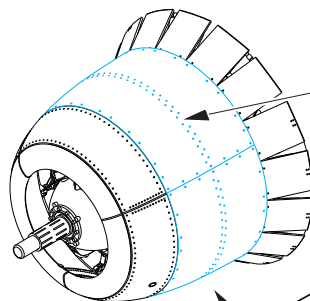
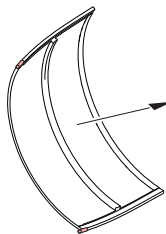

=

R12 ?

R11 ?

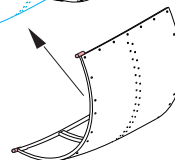

PE1

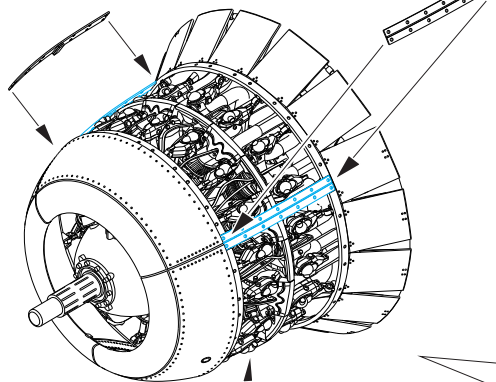

PE1

PE1



PE1 - 3 pcs.

